



VERTIKAL IS A NEW FRONTIER  
FOR ARTISTS, NFT COLLECTORS  
AND PIONEERS OF THE METAVERSE

# MORE AND MORE PEOPLE OWN DIGITAL ART AND NFTs

...and not everyone buys to flip. Many are growing attached to their collections, but **places to share, show and bring these collections to life are limited.**

Currently, NFT collections can be viewed either via online markets platforms like opensea that allow **no customization and curating** or...

...in metaverse settings that either **have to be built from scratch** (Decentraland, Sandbox) or are standalone virtual galleries (Cyber.xyz) that have **no or very little community aspect** to them.

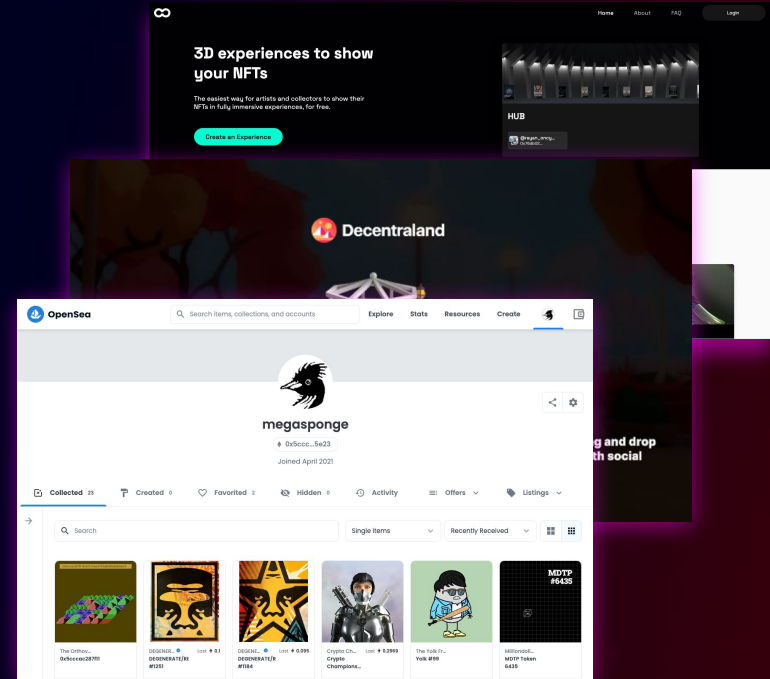



# VERTIKAL

CENTRAL PARK

## A METAVERSE... IN THE REAL WORLD

VERTIKAL is a 6,000-foot (1,810m) skyscraper that floats 555 feet (170m) above Umpire Rock on the west side of Central Park in New York.

The location was chosen as a tribute to New York's thriving art and NFT scene. The Met, MoMA, and the Guggenheim are just a walk away.

Situating VERTIKAL in a real place offers a host of real world interaction possibilities, through digital reality, localized collaborations, events and more.



TYCOON PAD #04 / LEVEL 95

Elevation: 1735m / 5692 feet

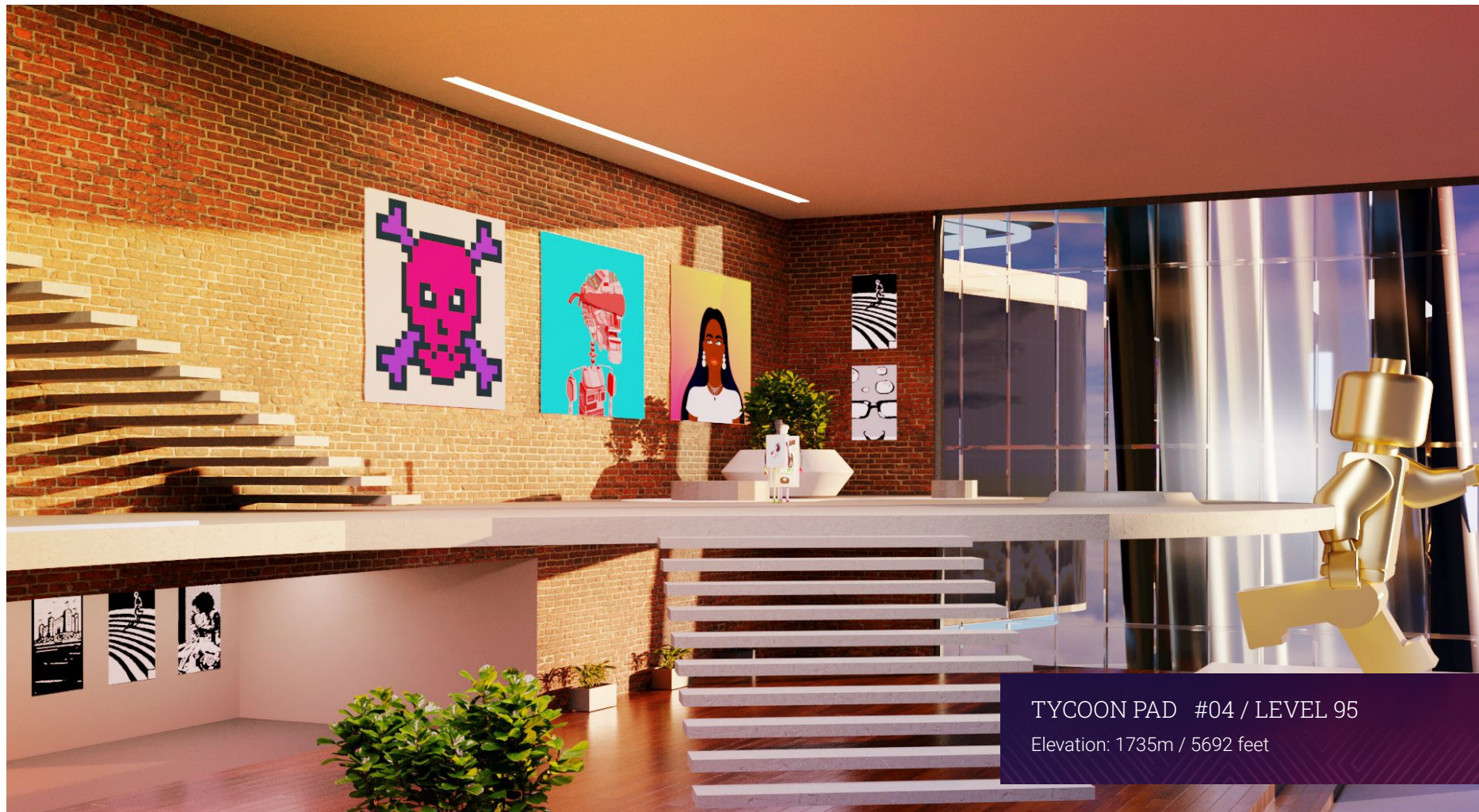

TYCOON PAD #04 / LEVEL 95

Elevation: 1735m / 5692 feet



BONSAI CLIFF / LEVEL #83

Elevation: 1278m / 4192 feet



BONSAI CLIFF / LEVEL #83

Elevation: 1278m / 4192 feet



## FOREST GARDEN

A taste of central park





OPEN ART SQUARE  
A space for 3D free expression



## MONUMENT GARDEN

Tribute to the eighties



VIEW UP VERTIKAL

Sunset with purple filter

# V-Pads available for sale



**HIVE**  
0.25 ETH



**LOFT**  
0.75 ETH



**PENTHOUSE**  
MAKE OFFER



**T-PAD**  
MAKE OFFER



**SKY-MANSION**  
MAKE OFFER

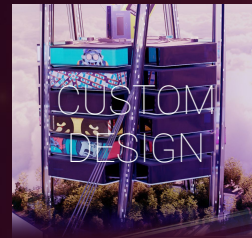

**FULL LEVEL**  
MAKE OFFER

# HIVE

SITUATED ON 50 LEVELS OF THE BUILDING  
TOTAL SUPPLY 25,000

Hives are the most compact spaces for sale in the building. They have a private entrance that overlooks the central plaza, and come in a variety of shapes and sizes that affect their rarity. Owners can display between 35 and 100 NFTs, digital artworks, photos or videos in Hives, depending on class. One NFT can be publicly displayed beside the entrance to the Hive.

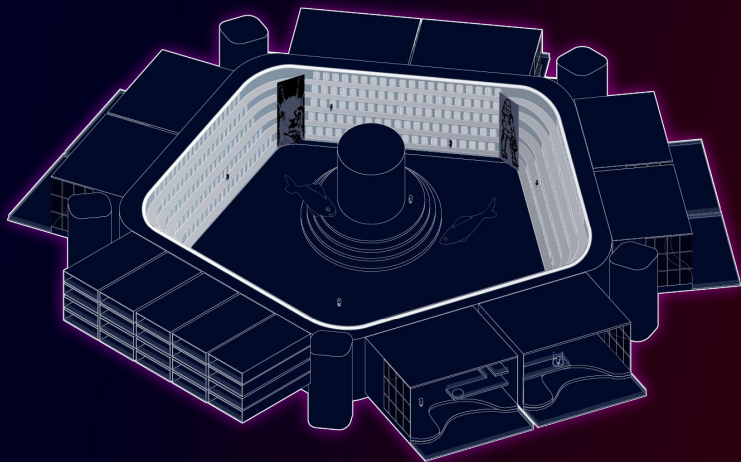

INITIAL DROP: TBC  
COST: 0.25 ETH

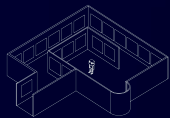

SHAPE 1  
14'000 of 25K / 56%



SHAPE 2  
7'000 of 25K / 28%

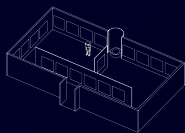

SHAPE 3  
3'000 of 25K / 12%

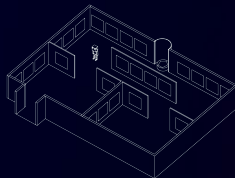

SHAPE 4  
800 of 25K / 3.2%

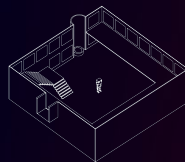

SHAPE 5  
180 of 25K / 0.72%

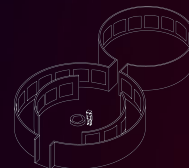

SHAPE 6  
19 of 25K / 0.08%

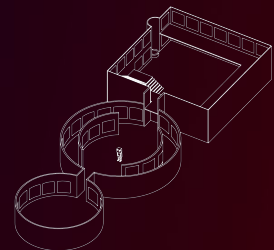

SHAPE 7  
1 of 25K / 0.004%

# HIVE

SAMPLE SPACE



Main picture: Neon Skin / art from the 500K collection  
Above: entrance doors with personal display screens



# LOFT

SITUATED ON 25 LEVELS OF THE BUILDING  
TOTAL SUPPLY 2,500

Lofts are situated on the outside of the building and are equipped with a balcony overlooking Central Park and Manhattan. They come in different classes that vary in size (one level or duplex) and features. A Loft can display 60 to 175 NFTs, digital artworks, photos or videos. Lofts have a private entrance situated on the concourse and can display up to 3 NFTs on the Plaza.

INITIAL DROP: TBC  
COST: 0.75 ETH

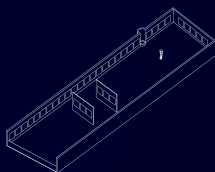
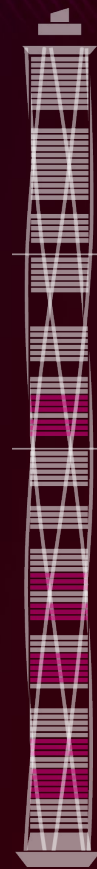
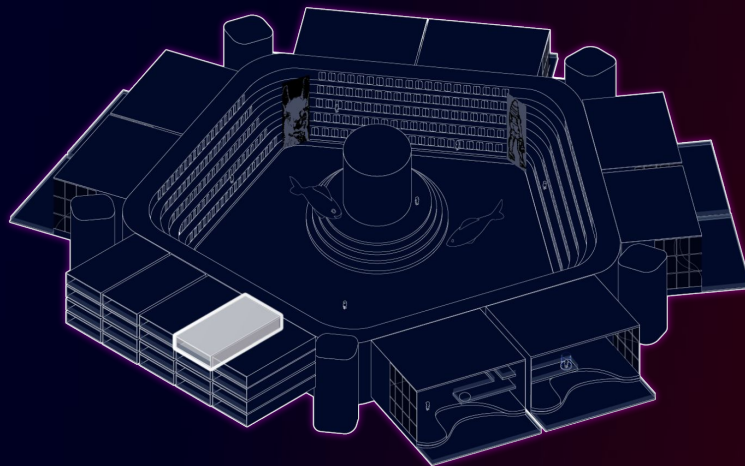

SHAPE 1  
1400 of 2.5K / 56%

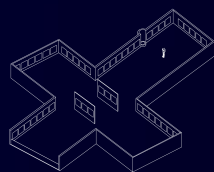

SHAPE 2  
700 of 2.5K / 28%

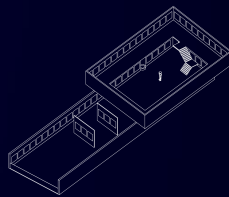

SHAPE 3  
300 of 2.5K / 12%

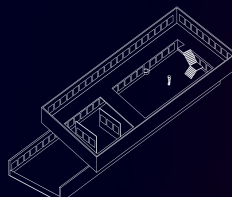

SHAPE 4  
80 of 2.5K / 3.2%

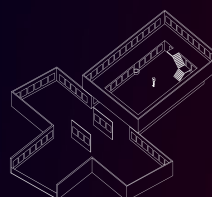

SHAPE 5  
19 of 2.5K / 0.76%

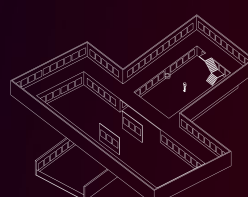

SHAPE 6  
1 of 2.5K / 0.04%

# LOFT

SAMPLE SPACE

As with all spaces, the interior design of a Loft can be chosen from a catalog of skins. It will also be possible to create custom skins or to access limited edition skins developed by artists and designers.



Main picture: Ushi Skin / art from the 500K collection  
Above: Old Warehouse Skin





# PENTHOUSE

SITUATED ON 25 LEVELS OF THE BUILDING  
TOTAL SUPPLY 250

Penthouses come with a spacious 3-story-high open-front lounge offering panoramic views of Manhattan, and an extendable terrace for entertaining. Another 3 levels of private gallery at the rear and a secret room offer the potential to display up to 250 NFTs, digital artworks, photos or videos. All Penthouses come with a private entrance, 5 public NFT display spaces and an optional giant exterior hologram to share your most beloved art piece with the world.

DROP QUANTITY: TBC  
**MAKE OFFER**

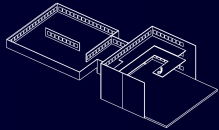
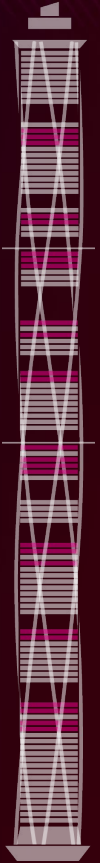
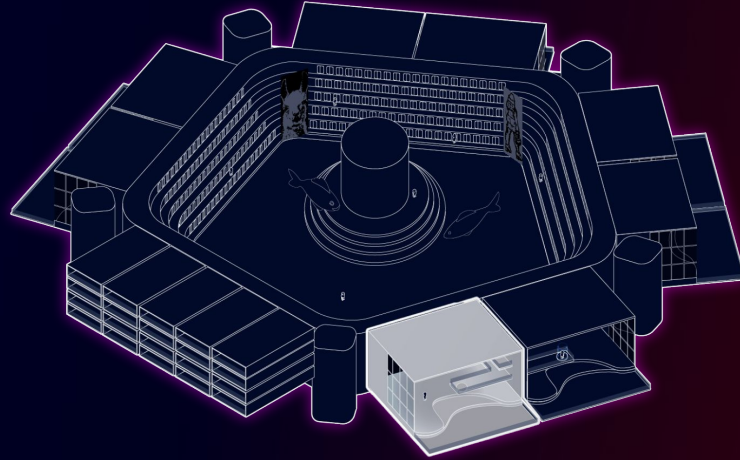

**SHAPE 1**  
160 of 250 / 64%

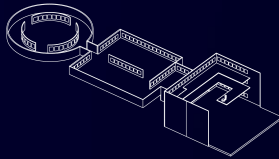

**SHAPE 2**  
50 of 250 / 20%

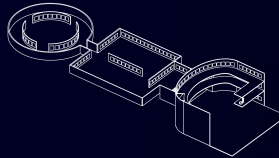

**SHAPE 3**  
25 of 250 / 10%

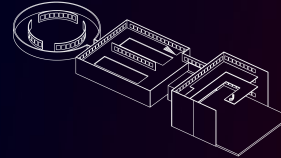

**SHAPE 4**  
10 of 250 / 4%

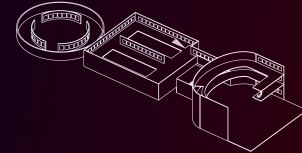

**SHAPE 5**  
5 of 250 / 2%

# PENTHOUSE

## SAMPLE SPACE

Like all spaces in the VERTIKAL building, Penthouses are designed to show an NFT art collection at its absolute best. They are equipped with a private entrance and can be open or closed to the public.

A teleport transports authorized avatars from anywhere in the building to the floating balcony, offering a full view of the NFT collection on one side and breathtaking views of Manhattan and Central Park on the other.

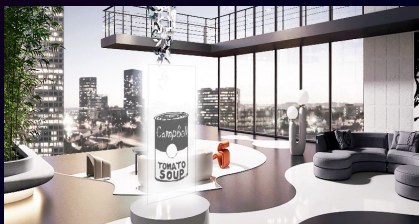

Meebit: courtesy SHERBS  
Art: 500K (rock legends collection)



# TYCOON PAD

SITUATED ON 5 LEVELS OF THE BUILDING  
TOTAL SUPPLY 25



T-Pads are ideal for entertaining and exhibiting very large NFT and digital art collections. The extremely spacious front lounge opens to the widest views the building has to offer. Situated at the top of the building, TPads are amongst the most prestigious spaces in VERTIKAL. In the back, 3 levels of galleries and 2 secret rooms allow the display of up to 500 NFTs, digital artworks, photos or videos. TPads come with a private entrance that offers 10 public NFT display spaces, a sound system and an optional giant exterior hologram.

DROP QUANTITY: TBC  
**MAKE OFFER**

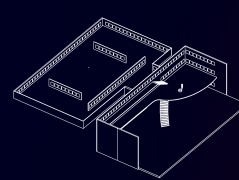
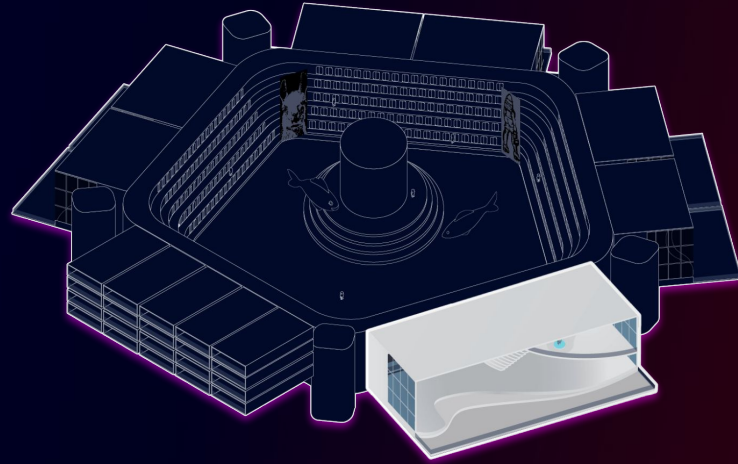

SHAPE 1  
14 of 25 / 56%

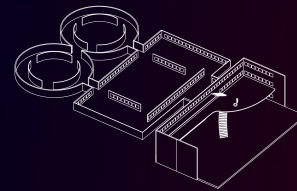

SHAPE 2  
9 of 25 / 36%

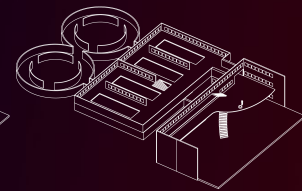

SHAPE 3  
2 of 25 / 8%

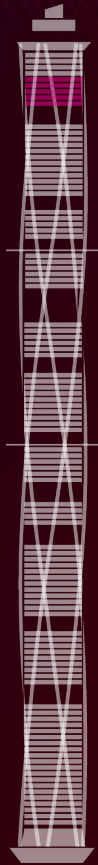

# SKY MANSION

SITUATED ON 3 LEVELS OF THE BUILDING  
TOTAL SUPPLY 5

There are only 5 Sky Mansions in VERTIKAL. Four of them occupy half a Level, and one is a double Sky Mansion occupying a complete Level, making it the largest (and rarest) space in VERTIKAL. Each Sky Mansion has been designed for use as a grand exhibition space and as a peerless venue for large events and prestigious social gatherings.

Adjacent to its main hall are multiple levels of exhibition galleries that can hold up to 1000 NFTs, digital artworks, photos or videos. An additional privatized VIP Suite is attached to the main hall by a sky bridge.

Each Sky Mansion also comes with numerous additional features, including multiple sound systems, extendable terraces, private entrance, secret rooms and much more.

DROP QUANTITY: 2  
**MAKE OFFER**

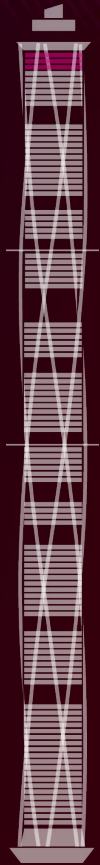
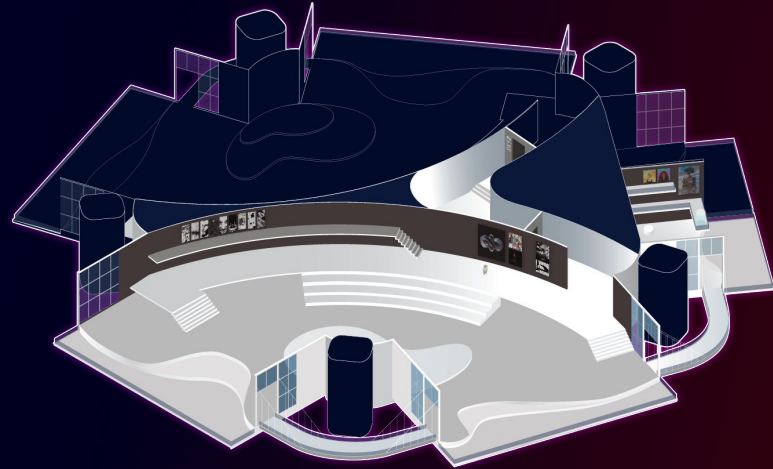

# PRIVATE LEVEL

SITUATED ON SEVERAL LEVELS OF THE BUILDING

Private Levels are created for the meta-entrepreneurs. The VERTIKAL team will work with the owner of a Private Level to develop his or her vision for the space. A Private Level is an opportunity to build a fully customized experience that will contribute to the overall VERTIKAL metaverse, and become part of the identity of the building.

Projects deployed in a Private Level can be for private use, community use, future resale, rental or commercial exploitation. The VERTIKAL team will share their knowledge and expertise to help the owner's team seamlessly integrate their vision for their Private Level into the VERTIKAL ecosystem.

DROP QUANTITY: TBC  
**MAKE OFFER**



# V-Pad Benefits

Unit	Hive	Loft	Penthouse	TPad	SkyMansion	Level
Ownership NFT	✓	✓	✓	✓	✓	✓
Votes in Level / Project Decisions	5	50	250	350	500	5000
Collect Rents from renting out	✓	✓	✓	✓	✓	✓
Custom Design	x	x	x	x	✓	✓
Skin NFT	1	1	2	2	Custom	Custom
Feature NFT	1	1	2	2	Custom	Custom
Portal NFT	1	1	2	2	Custom	Custom
Team NFT	1	1	2	2	Custom	Custom
Random NFT	1	1	2	2	Custom	Custom
MiningK NFT	2	3	4	5	6	Custom

# V-Pad Improvements



## SKINS

- Whole unit skins
- Ceiling Textures & Features
- Wall Textures & Features
- Floor Textures & Features
- Balcony Textures & Features
- Frames
- More...



## FEATURES

- Giant lego
- Disco Ball
- Fountain
- Neon door frames
- Dark mode
- Light mode
- Ape clock
- Randomator
- Hamster Wheel
- More...

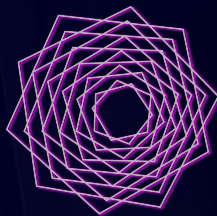

## PORTALS

- Silly Door
- Wormhole
- Slide
- Balcony Cannon
- Secret door
- Aquarium viewer
- IRL Weather Blob
- Instaframe
- More...



## COMPANY

- Pet Jaded Ape
- Pet Fish
- Pet Cat
- Pet Freddy
- Graffiti Wall
- Increase number of friends
- Butler bot
- Blob
- More...



## RANDOM

- Alarm system
- Fireplace
- Paint Cannon
- Sound system
- Video Console
- Photo booth
- Big Mic PA system
- Mushrooms
- More...



## Supporting Artists

VERTIKAL IS COMMITTED TO SUPPORTING DIGITAL AND NFT ARTISTS WITH THE FOLLOWING:

- ★ A 1 million dollar art fund whose proceeds belong to Vertikal token holders
- ★ A marketplace (the Grand Bazar) where resident artists can mint and sell their art with no fees or commissions (excluding gas)
- ★ Private display areas to showcase their art (purchase or win a unit)
- ★ Public display areas, events and commissions to help increase exposure
- ★ MoonShot programme where we help launch new NFT collections
- ★ Penta NFT Art Show



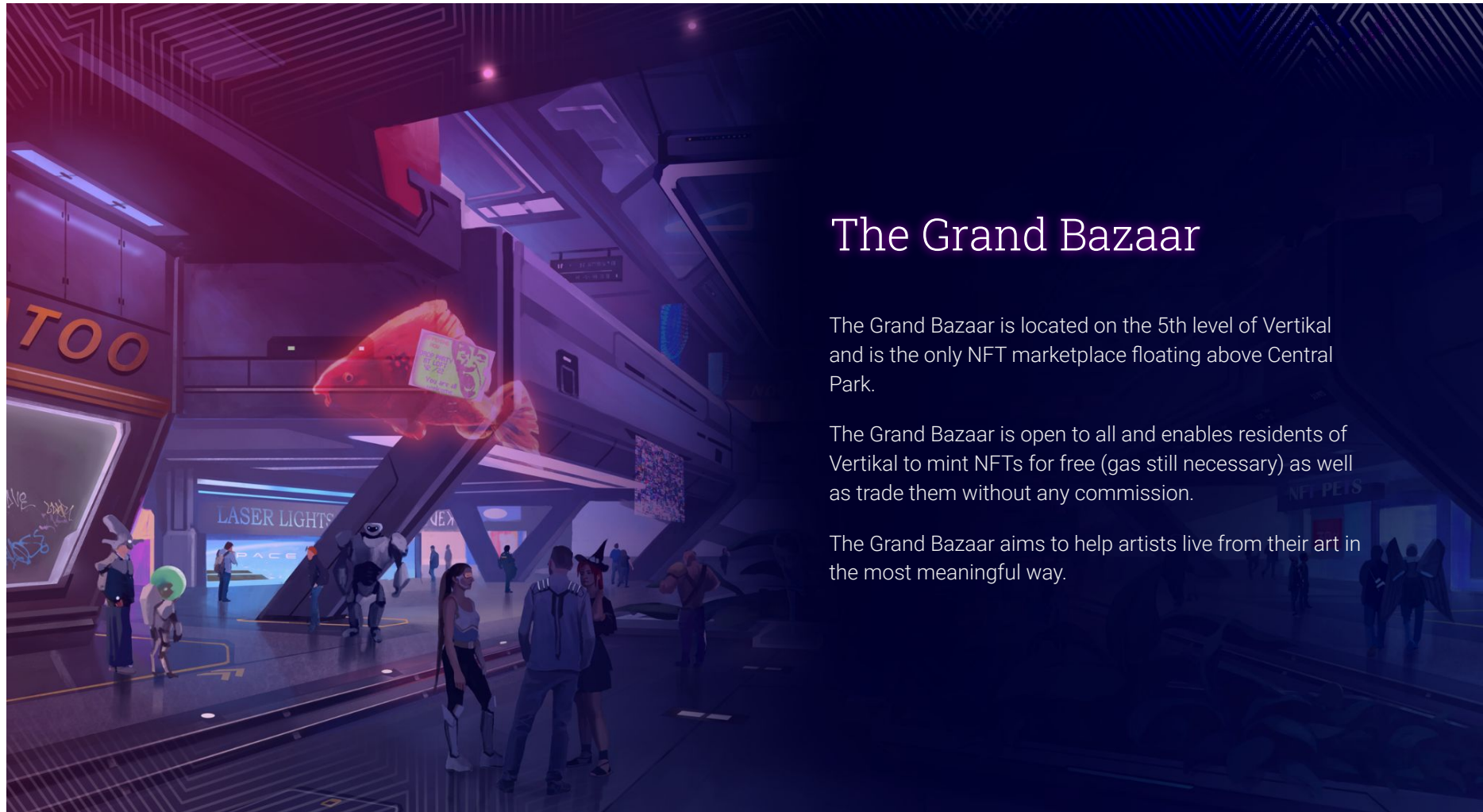

## The Grand Bazaar

The Grand Bazaar is located on the 5th level of Vertical and is the only NFT marketplace floating above Central Park.

The Grand Bazaar is open to all and enables residents of Vertical to mint NFTs for free (gas still necessary) as well as trade them without any commission.

The Grand Bazaar aims to help artists live from their art in the most meaningful way.

# Web3 Museums

Vertikal is reserving a number of floors for exhibitions by leading museums of the world both in both traditional, digital and NFT art.

The following levels are reserved for:

- ★ The METAL Ouvre (Floor 93)
- ★ The MEMOMA (Floor 80)
- ★ The META BM (Block 65)
- ★ The Hokusai & Anime METACenter (Block 47)

We hope they will join us!

Other temporary galleries and exhibition spaces will be shared with other leading museums of the world.

Detail of Mona Lisa by Leonardo da Vinci / Bored Ape courtesy Rinko

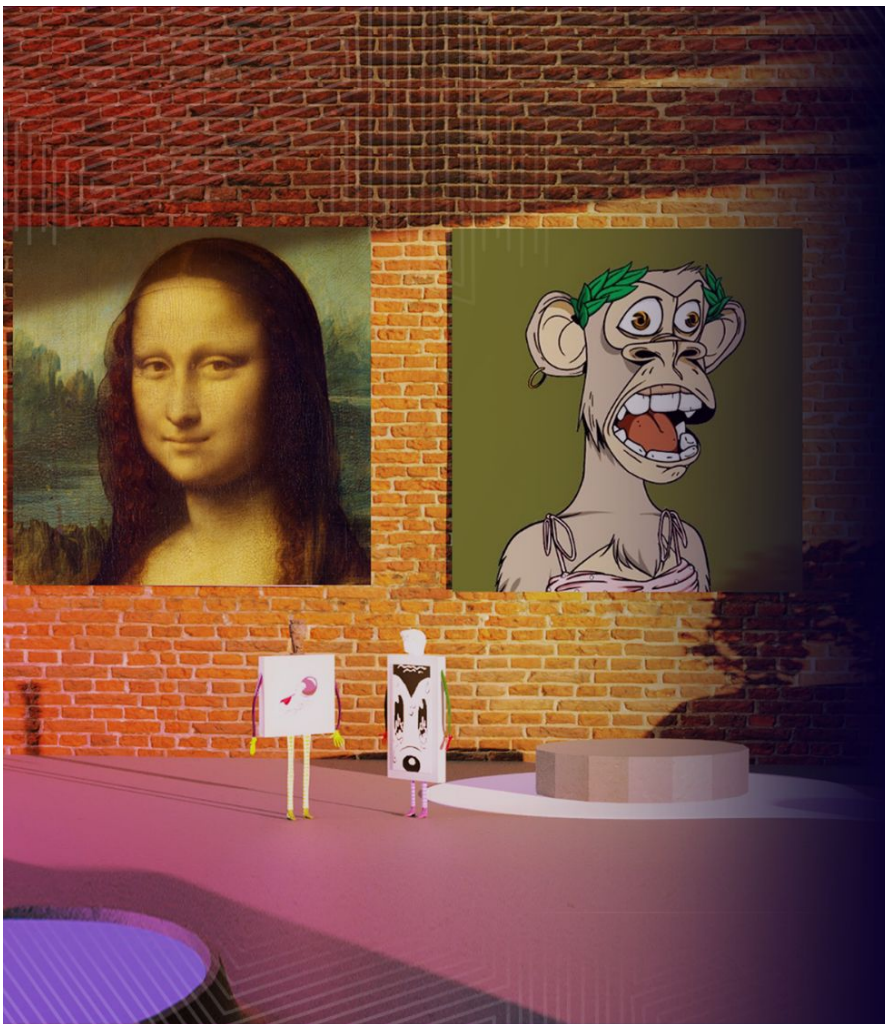

# Vertikal Is Backed By One Of The Largest Digital Art Collections In The World

VERTIKAL is the permanent home of 500K, the largest body of hand drawn digital art in the world, a rich and mesmerizing collection of half a million pieces capturing 20 years of internet history.

The collection will be shown through temporary exhibitions curated by theme, artist, or in collaboration with other projects.

A “Hall of Notorious Draws” situated at the top of the VERTIKAL building will feature, in a permanent exhibition, the most iconic pictures of the collection and tell the story of this monumental piece of digital art history.

Check out <https://500k.art/> for more



**500K**  
**A WORLD OF RAW EXPRESSION**

# Visual & Performing Art Program

ONE OF THE CORE AMBITIONS OF VERTIKAL IS TO CREATE A THRIVING ART ECOSYSTEM FOR ITS COMMUNITY AND THE LARGER PUBLIC.

## CURATED EXHIBITIONS

VERTIKAL is engaging established figures of the art and NFT scene to curate art shows that are displayed in the Grand Hall and the exhibition spaces distributed throughout the building.

## COLLABORATIONS & RESIDENCIES

A program of collaboration with artists, collectors, charities and real world venues is being established so partners can benefit from each others' platforms. Selected artists are invited as VERTIKAL residents and offered space, resources and mentorship to support one of their projects.

## DAO EVENTS

Each Level in the VERTIKAL building is run as a Decentralised Autonomous Organisation (DAO). The community is given the means to organise the way the central plaza is developed and animated, giving them the option to work with designers and artists to create their own unique art and event programs.



## DOME EVENTS

The Manhattan panorama visible from all VERTIKAL outerspaces and gardens has been augmented so it can be used to stage performing art events and live shows. Events will be programmed on the dome by VERTIKAL and partners on a regular basis.



## Vertikal Communities

Each Level in VERTIKAL is a virtual village. The central Plaza or Village Green is its focal point, a place for the community to meet, to share, and to enjoy art and life.

Each Level acts as a Decentralised Autonomous Organisation where important aspects are voted upon by local residents.

# It's Not Just Real Estate

Becoming an owner of a space at VERTIKAL makes you a V-Kay (pronounce VeeKay). V-Kays have voting rights on decisions concerning the overall project as well as those affecting the Level where their property is situated.

V-Kays with property situated on the outside of the building (outerspaces) benefit from front row views of events staged by VERTIKAL and our partners on the Manhattan vista.

The V-Kay status grant discounts to paid events and exhibitions as well as exclusive access to private gardens and V-Kay only spaces situated in the building. The VERTIKAL team is developing partnerships within the art world and with other Metaverses and NFT projects, and is passing on the benefits to the V-Kay community.

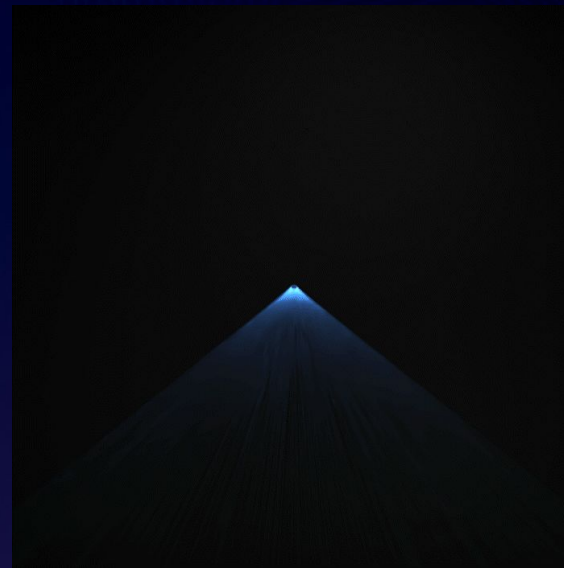

## **V-KODES**

Each property owner will receive a V-Kode with a unique proprietary "finger print" design. The VERTIKAL App will be able to scan V-Kodes giving direct access to the corresponding space (subject to the owner's authorization, of course).

# Sky-G Club

The Vertikal Sky G Club is an exclusive invite only club with 555 members which lives on the Moon Deck is the highest private space in Vertikal.

For egalitarian purposes the Club is open by invitation to residents and non-residents.

BENEFITS OF THE VERTIKAL SKY G CLUB INCLUDE:

- ★ Access to the Moon Deck (Top Mast)
- ★ Private Drops
- ★ Additional Votes
- ★ Benefits reserved for Members
- ★ IRL Meetings & Events
- ★ Vertikal Swag



# Team

VERTIKAL is backed by a team of 18 fully doxxed pioneers, creatives and NFT aficionados building a metaverse dedicated to what we love: creativity, art and collectibles.

The team is comprised of experts in different disciplines making sure only the highest quality art, UX, tech, security and value is delivered.

We've been building this project for more than a year now and are launching soon.

## FOUNDERS



PETE  
HOLBERTON  
Doyen of Data



LOUIS  
PASCHOUD  
Metaverse  
Alchemist



JPE  
DUMAS  
Inspiration  
Olifant

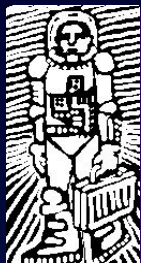

RICHARD  
PIACENTINI  
Blockchain  
Illuminator



HARRY G.B.  
CRABTREE  
Conversation  
Architect



ALEX  
King Connector



JAE  
Asia Shaman



Ji  
Asia Sensei



YULIYA  
Enchanter of  
3Ds



MANUEL  
3D Wizard



HALIL  
Interior  
Shaman



ANDRII  
Animotion Guru



THAKY  
Code Weaver



NINE  
Code Wrangler



BENGRI  
Code Dancer



EMILE  
Discord  
Sorcerer



ADDI  
Community  
Artist



PRIAO  
Nux Capacitor



# Vertikal Runs On The Latest Technology

VERTIKAL IS BACKED BY THE LATEST IN BLOCKCHAIN AND 3D TECHNOLOGY TO ENSURE THE HIGHEST QUALITY UX, BEST IN CLASS FEATURES AND ENTERPRISE GRADE SECURITY.

## BLOCKCHAIN

Our Smart Contracts are based on ERC721 standards on the Ethereum blockchain. Magic Minting and Voucher Validation ensure both the lowest gas fees possible, as well as security and fairness built into the contracts.

## IMMUTABLE STORAGE

All graphical content is stored on IPFS and secured by a dedicated IPFS node run by VERTIKAL which ensures the security of the VERTIKAL assets as well as contributing to make other projects more secure and immutable.

## METAVVERSE 3D ENGINE & GAME RENDERING

VERTIKAL is based on the Unity engine and incorporates community building tools for AR and VR from NVIDIA's latest Metaverse 3D creation platform, specifically chosen for its community building capabilities.

# Road Map I

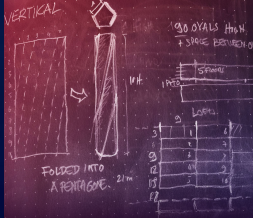

## 2021

Project beginnings  
Team set up  
Concept development  
Architectural planning  
Blockchain model and tokenomics

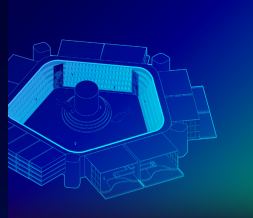

## Q1 2022

2D Tower Modelisation  
Twitter Launch  
Discord Launch



## Q2 2022

Video presentation of Vertikal  
Website launch  
Public Sale  
Creation of the Vertikal Art Fund  
Launch for Vertikal permanent collection  
Penta NFT art awards call for entries



## Q3 2022

Reveal of new Spaces on the floors of Vertikal  
Penta NFT art awards results, IRL Ceremony and Show  
Launch of Vertikal Vista app and platform  
IRL (In Real Life) Events  
First curated expos



## Q4 2022

Metaverse Pre-Launch  
Opening events and concert  
Metaverse Ceremony  
NFT Penta ART Show  
IRL Events



## Q1-Q2 2023

Metaverse Art Openings  
IRL Events  
OpenSpace competitions  
Ambition: Token Launch TBC

Thank You



[vertikal.art](https://vertikal.art)



[@VertikalArt](https://twitter.com/VertikalArt)



[discord.gg/Vertikal](https://discord.gg/Vertikal)