

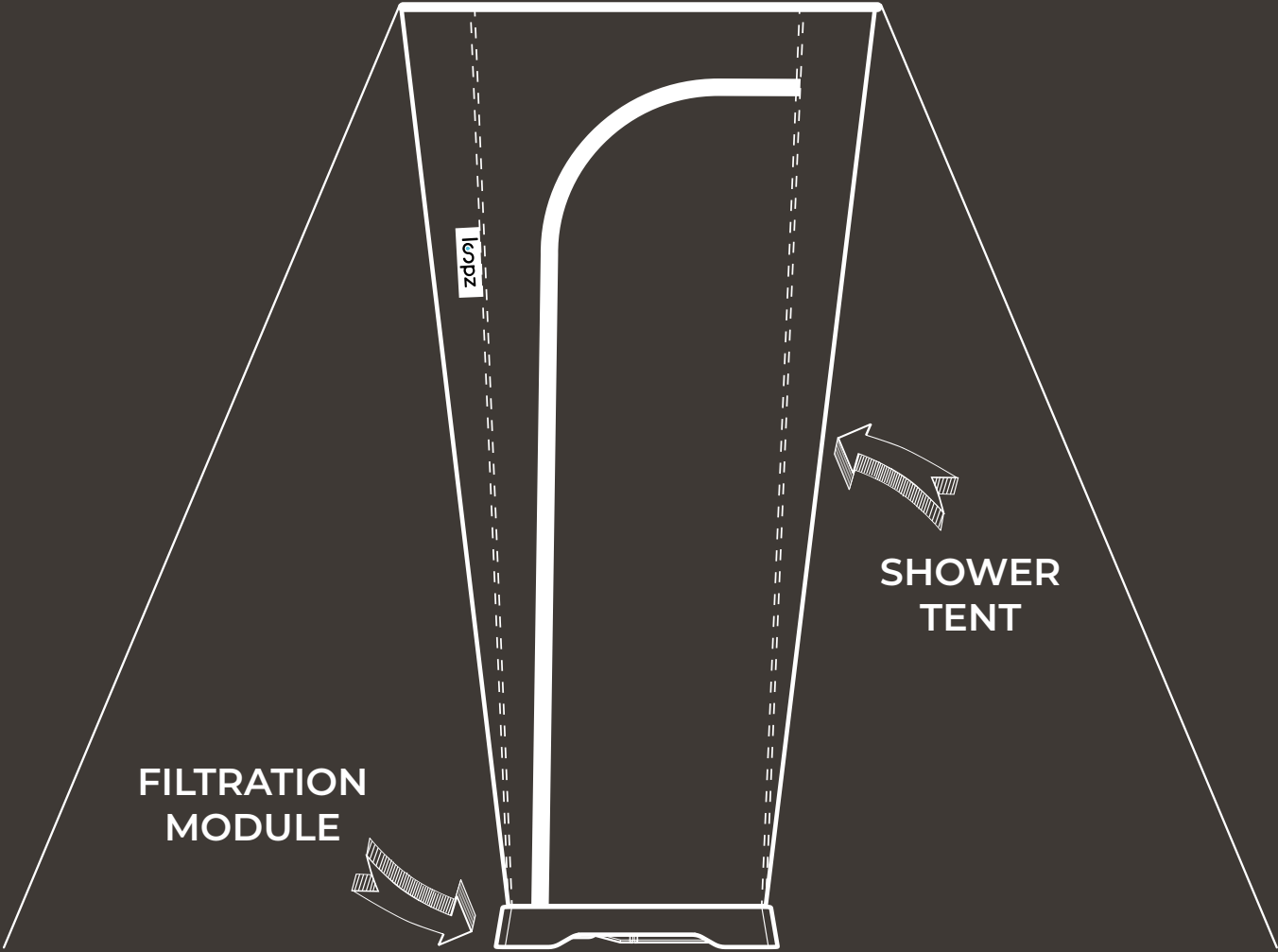

Loopz specifications



Filtration Module

What is included?

- 1x Shower Tray 65x65x10cm
- 1x Shower deck, wood composite
- 1x Holder microfilter
- 1x Loopz electro mechanical panel including:
 - Stainless steel frame
 - 12VDC pump
 - 12VDC UV-C module
 - Stainless steel start/stop button
 - Level sensor
 - 30cm connection cable
- 5x Spare microfilter
- 1x User manual
- 1x Transportation bag

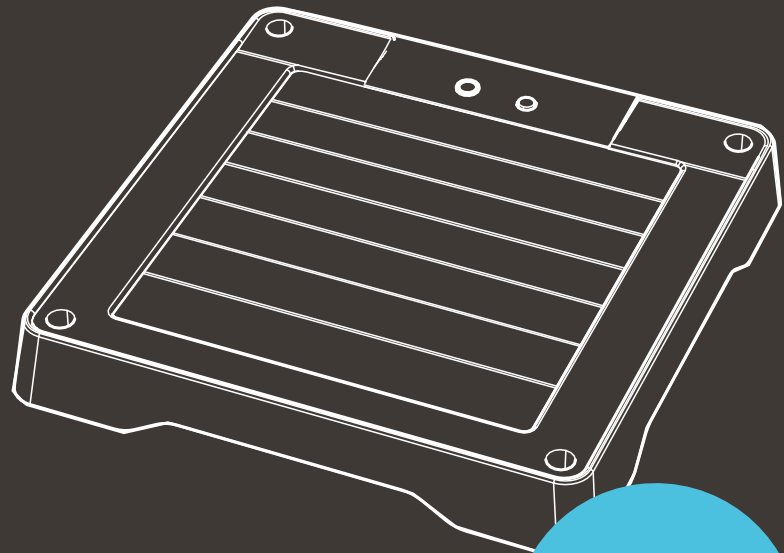

Filtration Module is available separately

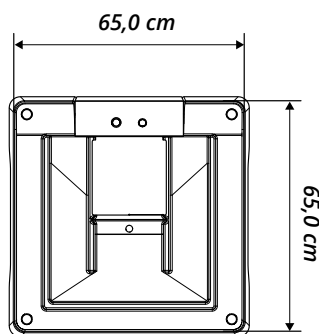

Top view Filtration Module

Size and Weight

Shipping

Size: 70x70x12cm / 27x27x5"
Weight: 10kg / 22lbs

Nett

Size: 65x65x10cm / 25x25x4"
Weight: 8kg / 17,5lbs

Usage

- In combination with the Loopz Shower Tent (see page 5)
- DIY Van Builds
- Mobile Homes

For fixed installation always contact your installer to ensure that the installation meets local requirements and building codes.

Electrical specifications

- 12VDC input
- 27W max power consumption
- Overvoltage protected
- CE compliant
- Connects to optional adapters
- IP65 connector

How to power the Loopz Filtration Module

Universal Power adapter

The Loopz Filtration Module can be connected to any 12V Power adapter with a rated power of 30W or better. We offer one as an optional Perk.

Adapter for Car Lighter outlet

The Loopz Filtration Module can be connected to any 12V Car Lighter outlet with a rated power of 30W or better. We offer the adapter cable as an optional Perk.

USB-C (PD)

The Loopz Filtration Module can be connected to any power bank or USB-C power adapter with Power Delivery (30W or better). We offer the adapter cable as an optional Perk.

How does the Filtration Module work?

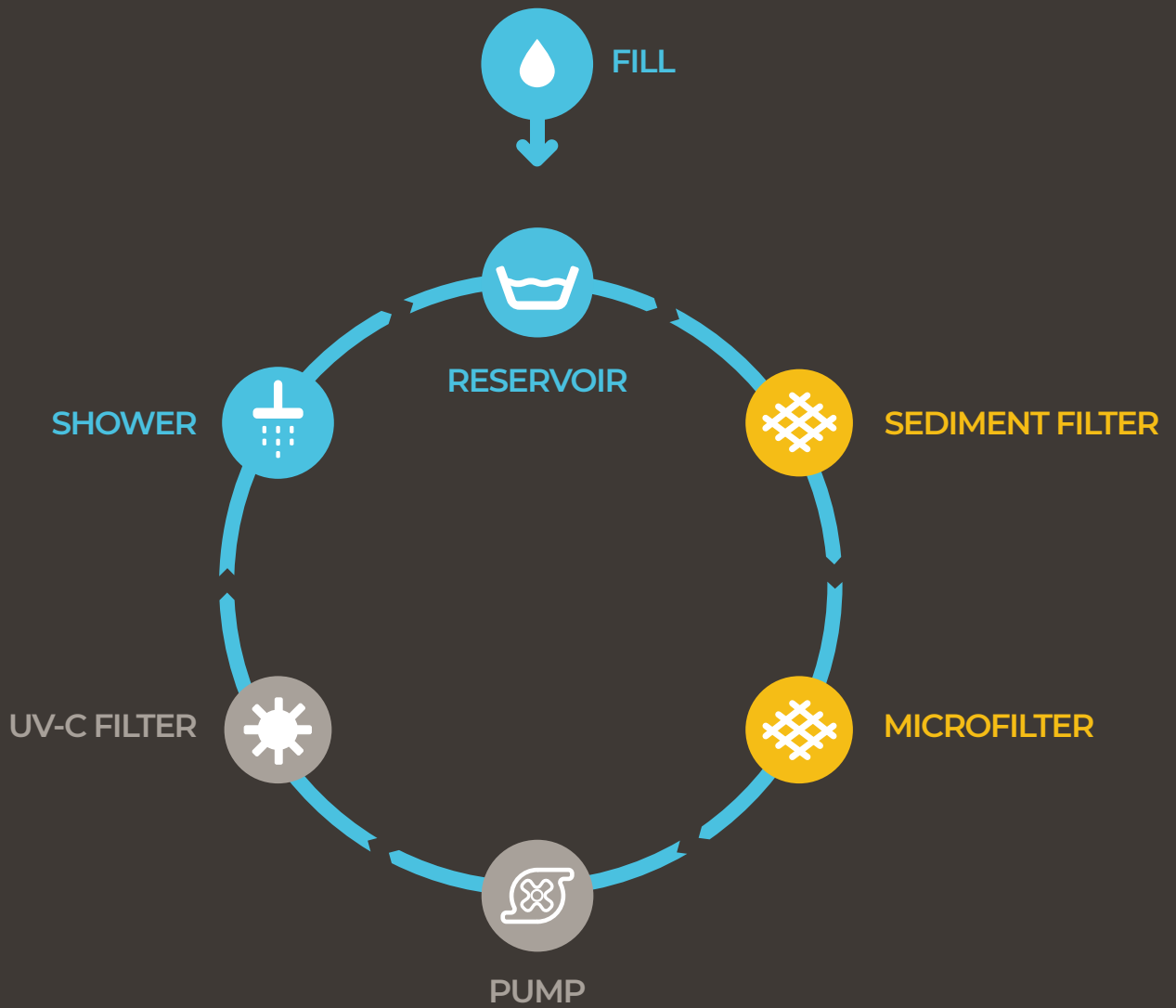



Sediment Filtration

- Loopz tray of 65x65x10cm (approximately 2x2 feet, 4")
- Composite, heavy duty shower deck
- Deck is placed above the shower tray: you don't stand in the water
- Tray is specifically designed for optimal flow to the filter
- Sediment particles, sand will be collected in the tray
- Tray can be easily cleaned



Mechanical Microfiltration*

- Polypropylene needle felt
- Staple fiber technology
- 1,5mm thickness
- 40micron filter
- Large surface area of 7x20cm (ensure low flow)
- High filtration efficiency
- Low pressure loss
- Stable filtration efficiency
- Can be easily replaced & rinsed
- Low costs replacements available

* Purchase includes 5 spare microfilters

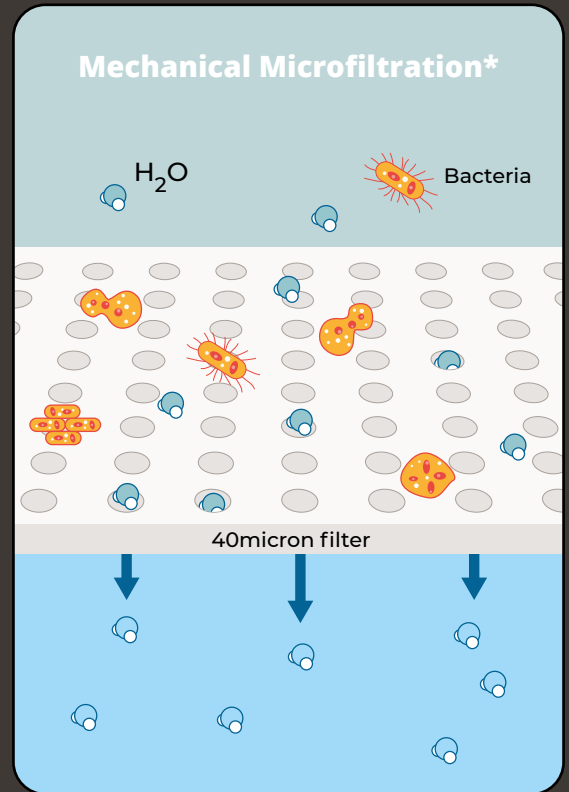

UV-C Filter

- LED technology
- Mechanically robust
- IP68
- Tested and Certified by NSF International against NSF/ANSI 55- 2019
- Constant UV-C output regardless of water temperature.
- CE (2014/30/EU; 2011/65/EC; 2001/95/EC)
- 14MJ/cm2 Disinfecting Performance
- 4-Log (99.99%) inactivation of various common organisms
- Max power rating of the UV-C Led: 18W
- LEDs do not transfer heat to the water, thus limiting fouling
- UV-LEDs have a constant UV output regardless of water temperature
- Estimated Lamp Lifetime: 8000 hours

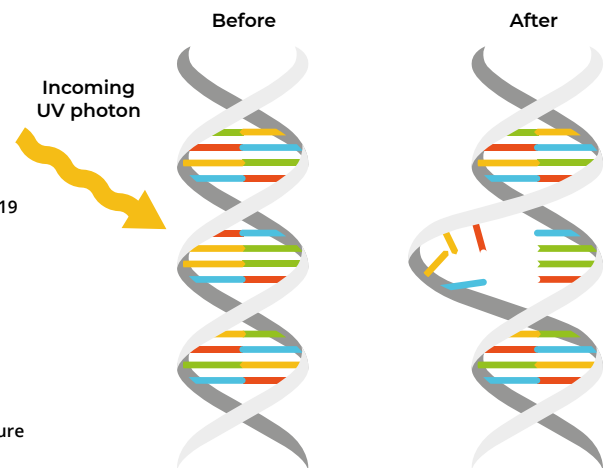

An LED produces a pre-selected wavelength from a small amount of electricity. The LED then emits UV-C photons through the water that penetrate the cells and damage the nucleic acid in the microorganism DNA. As these cells cannot replicate, it renders the harmful microorganism inactive. As a result, UV-C LEDs allow for high-intensity radiation to kill the bacteria in seconds, and its effectiveness is measured in LOGs.

Loopz collaborates with Aquisense Technologies, for more info about the UV-C light check www.aquisense.com/technology.

Loopz, the Endless Shower

What is included?

- 1x Filtration Module (complete module, see page 2)
- 1x Shower Tent
- 1x Tent frame
- 1x User manual
- 1x Transportation bag

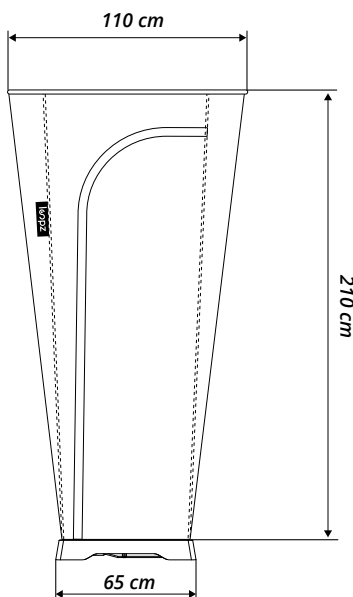
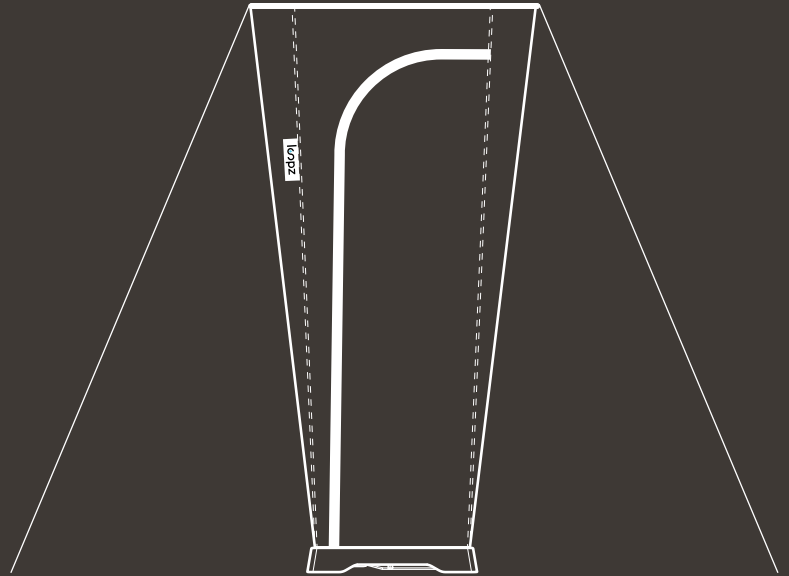

Front view Loopz

Size and Weight

Shipping

Size: 70x70x18cm / 27x27x7"

Weight: 16kg / 35lbs

Nett

Size(Folded): 65x65x15cm / 25x25x6"

Size (Loopz in Use): 65x65x210cm / 25x25x83"

Weight: 15kg / 33lbs

Shower Tent

- Fabric: Valmex 4213
- Durable weatherproof material
- Aluminum Lightweight Poles
- Tent can be secured by guy lines (included)
- Spacious design through cone shape
- Mesh top for ventilation
- Storage compartment on top

Loopz collaborates with Karsten Tents, for more info about the these tents check www.karstententen.com.



Hamwells®

Pelgrimsstraat 3, 3029 BH Rotterdam, The Netherlands
+31 85 - 303 64 96, info@hamwells.com, www.hamwells.com

Hamwells provides this information to the best of our knowledge. These specifications are preliminary and subject to change due to the nature of an Indiegogo campaign. All rights reserved. Terms and conditions of Hamwells Nederland B.V. apply to all our shipments and products.